



# aquatix<sup>®</sup>

equipment for very aquatix people

AQUAFITNESS ADVANCED



Release: 2020, October

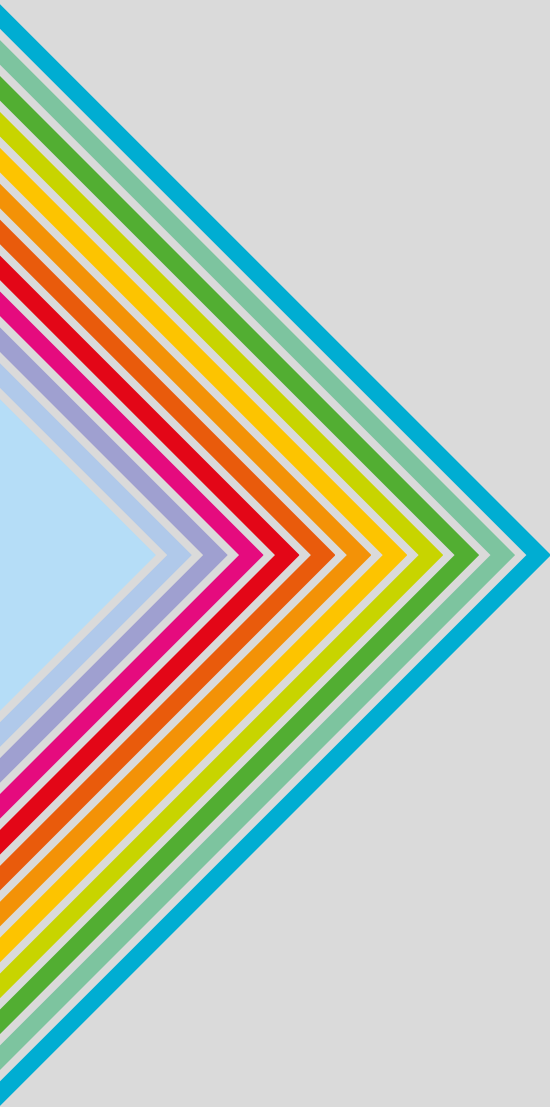

## Index

5	<b>BPM AQUABIKE</b>
7	<b>ACTIVE AQUABIKE</b>
9	<b>SMART UP + AQX AQUABIKES</b>
11	<b>GALAXY AQUABIKE</b>
15	<b>STAR AQUATREADMILL</b>
17	<b>STANDARD AQUATREADMILL</b>
21	<b>MOON WALKER</b>
23	<b>ROUND JUMP</b>
25	<b>WATER UP &amp; DOWN</b>
29	<b>FLOAT2FITNESS</b>
31	<b>VERTICAL DYNAMIC</b>
33	<b>AQUA FITNESS MAT</b>
35	<b>SUP</b>
37	<b>PUZZLE STEP</b>
39	<b>MOON BITE &amp; AQQUA CIRCLE STEP</b>
19	<b>Circuit examples</b>



YouTube links

## Icons



**CORSI DI FORMAZIONE\***  
TRAINING COURSES\*



**CARATTERISTICHE TECNICHE**  
TECHNICAL FEATURES



**ESEMPI CIRCUITI**  
CIRCUIT EXAMPLES



\* Tutti i prodotti Aqqatix sono raccomandati da EAA

\* All Aqqatix products are recommended by EAA

[www.euroaquatic.it](http://www.euroaquatic.it)



AQUABIKE



## BPM AQUABIKE TWO

- + AQUABIKE MADE IN ITALY
- + EXCLUSIVE ITALIAN DESIGN
- + SCOCCA IN POLIETILENE  
POLYETHYLENE SHELL
- + REGOLAZIONE INTENSITÀ PEDALATA  
BRAKING SYSTEM
- + MANUBRIO ERGONOMICO  
ERGONOMIC HANDLEBAR
- + PRODOTTO MARCHIATO CE  
CE MARKED PRODUCT
- + NUOVE BASI RINFORZATE  
NUOVE BASI RINFORZATE



L'esclusivo sistema di regolazione dell'intensità di pedalata di **BPM AQUABIKE TWO** permette di modificare la resistenza, anche durante l'attività, senza interruzioni

The **BPM AQUABIKE TWO's** exclusive pedalling intensity adjustment system allows you to adjust the resistance, even during the activity, without any interruptions



Nuovo alloggiamento del piede in Eva Foam  
New foot rest in Eva Foam





### EAA INSTRUCTOR TRAININGS:

Master **AQUABIKE**

Master **AQUA CIRCUIT**

Master **AQUAxFIT®**

Course **AQUA PERSONAL PROGRAM**



<b>Materiale</b> Material	Polietilene Inox AISI 316L
<b>Profondità d'impiego</b> Depth of use	100 - 140 cm
<b>Intensità pedalata</b> Cycling intensity	Regolabile Adjustable
<b>Peso</b> Weight	26 kg

### QUALI VENTOSE SCEGLIERE? WHICH KIND OF SUCTION CUP?



**AFA RGEN 003**  
consigliata per vasche con **SUPERFICI LISCE** (pvc liscio, ceramica liscia...) suggested for **SMOOTH SURFACE** pools (smooth pvc, smooth ceramic...)



**AFA RGEN A03**  
consigliata per vasche con **SUPERFICI SEMI RUVIDE O IRREGOLARI** (mosaico, inox bugnato, ceramica ruvida, pvc ruvido...) suggested for **UNEVEN OR IRREGULAR SURFACE** pools (mosaic, embossed stainless steel, rough ceramic ruvida, rough pvc...)

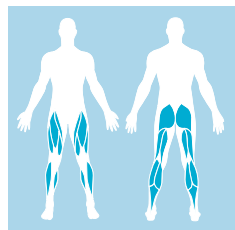

BPM AQUABIKE è la migliore soluzione per qualsiasi attività dove la pedalata è la forma principale di movimento.

- Design unico al mondo, elegante e funzionale: scocca in polietilene e telaio inox con profili ovali.
- Il freno, studiato dal Centro R&D per una maggiore durata nel tempo, permette di modificare l'intensità della pedalata anche durante l'utilizzo, senza interruzioni dell'esercizio.
- Manubrio ergonomico, studiato per diversificare la posizione delle mani e verniciato per migliorare il grip della presa.
- Pedale resistivo in polietilene, design studiato per rendere più fluida ed efficace la pedalata.
- L'eccellente stabilità della bike è assicurata dal perfetto equilibrio avantreno/retrotreno, dalle nuove basi rinforzate e dalle quattro ventose in pvc trasparente.
- L'angolo sella-manubrio di 74°, assicura la miglior posizione nell'utilizzo, escludendo regolazioni orizzontali della sella.
- Le ruote anteriori agevolano la movimentazione della bike durante l'uscita dall'acqua e a bordo vasca.
- 3 varianti colore d'effetto, con possibilità di ordinare anche la variante Yellow, con minimo d'ordine 10 pz. e 60 gg di consegna.

BPM AQUABIKE is the best solution for any activity where pedalling is the main form of movement.

- Unique design, elegant and functional: polyethylene shell and stainless steel frame with oval profiles.
- The brake, designed by the R&D Centre to achieve greater durability, allows you to change the pedalling intensity even while the bike is being used, without interrupting the exercise.
- Ergonomic handlebar, designed to increase the hand positions and painted to improve grip.
- Resistive polyethylene pedal, designed to make pedalling smoother and more effective.
- The excellent stability of the bike is ensured by the perfect balance between the front and rear axes, thanks to its new reinforced bases and four suction cups in transparent PVC.
- The 74° seat-handlebar angle ensures the best position during use, excluding horizontal seat adjustments.
- The front wheels facilitate the movement of the bike when exiting the water and on the poolside.
- 3 dazzling colour variants, plus the option of ordering the Yellow variant, with a minimum order of 10 pieces and delivery within 60 days.

## BPM AQUABIKE

mod. **TWO**

cod. AFA BPM 002

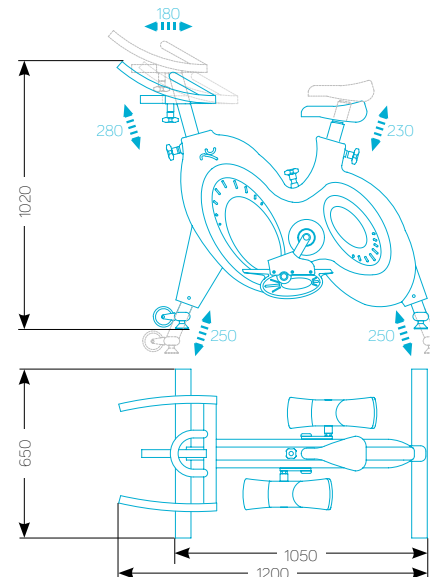



Regolazione orizzontale manubrio  
Horizontal handlebar adjustment

Manubrio ergonomico verniciato  
Ergonomic varnished handlebar

Il sistema di regolazione dell'intensità di pedalata di **ACTIVE AQUABIKE** permette di modificare la resistenza, anche durante l'attività, senza interruzioni  
The **ACTIVE AQUABIKE's** exclusive pedalling intensity adjustment system allows you to adjust the resistance, even during the activity, without any interruptions



Profili tondi antinfortunio  
Round safety bars

Regolazione meccanica intensità della pedalata  
Mechanical intensity adjustment

## ACTIVE AQUABIKE

- + AQUABIKE MADE IN ITALY
- + EXCLUSIVE ITALIAN DESIGN
- + PROFILI TONDI ANTINFORTUNIO  
ROUND SAFETY BARS
- + REGOLAZIONE INTENSITÀ PEDALATA  
BRAKING SYSTEM
- + MANUBRIO ERGONOMICO  
ERGONOMIC HANDLEBAR
- + PRODOTTO MARCHIATO CE  
CE MARKED PRODUCT



Alloggio piede in Eva Foam  
Foot rest in Eva Foam

Pedale resistivo  
Resistive pedal

Nuovo alloggio del piede in Eva Foam  
New foot rest in Eva Foam



Versione in acciaio verniciato nero  
Black painted frame version

Ventose trasparenti antimacchia  
Non-staining suction caps

Ruote gommata  
Rubber wheels



White

Yellow

Lime

Orange



### EAA INSTRUCTOR TRAININGS:

Master **AQUABIKE**

Master **AQUA CIRCUIT**

Master **AQUAxFIT®**

Course **AQUA PERSONAL PROGRAM**



**Materiale**  
Material

Inox AISI 316L  
316 L stainless steel

**Profondità d'impiego**  
Depth of use

100 - 140 cm

**Intensità pedalata**  
Cycling intensity

Regolabile  
Adjustable

**Peso**  
Weight

22,5 kg

### QUALI VENTOSE SCEGLIERE? WHICH KIND OF SUCTION CUP?



**AFA RGEN 003**  
consigliata per vasche con **SUPERFICI LISCE** (pvc liscio, ceramica liscia...) suggested for **SMOOTH SURFACE** pools (smooth pvc, smooth ceramic...)



**AFA RGEN A03**  
consigliata per vasche con **SUPERFICI SEMI RUVIDE O IRREGOLARI** (mosaico, inox bugnato, ceramica ruvida, pvc ruvido...) suggested for **UNEVEN OR IRREGULAR SURFACE** pools (mosaic, embossed stainless steel, rough ceramic ruvida, rough pvc...)

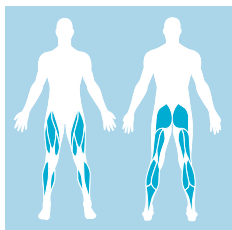

ACTIVE è Il modello di Aquabike in acciaio inox, ottimo per qualsiasi attività dove la pedalata è la forma principale di movimento, dal design unico, elegante e funzionale.

- Carter in 4 varianti colore d'effetto, è studiato per la sicurezza durante la pedalata.
- Il freno, studiato dal Centro R&D per una maggiore durata nel tempo, permette di modificare la resistenza, anche durante l'attività, senza interruzioni dell'esercizio.
- Telaio in acciaio con profili arrotondati, verniciato nel mod. BLACK.
- Manubrio ergonomico, studiato per diversificare la posizione delle mani e verniciato per migliorare il grip della presa.
- Pedale resistivo in polietilene, dal design studiato per rendere più fluida ed efficace la pedalata.
- Ottima stabilità, assicurata dal perfetto equilibrio avantreno/retrotreno, dalle basi ben dimensionate e dalle quattro ventose in pvc trasparente.
- L'angolo sella-manubrio di 74°, assicura la miglior posizione nell'utilizzo, escludendo regolazioni orizzontali della sella.
- Le ruote anteriori agevolano la movimentazione della bike durante l'uscita dall'acqua e a bordo vasca.

ACTIVE is the Aquabike model in stainless steel, excellent for any activity where pedalling is the main form of movement, with a unique, elegant and functional design.

- Carter in 4 dazzling colour variants, designed to ensure safety while pedalling.
- The brake, designed by the R&D Centre to achieve greater durability, allows you to change the resistance, even during the activity, without interrupting the exercise.
- Steel frame with rounded profiles, BLACK model.
- Ergonomic handlebar, designed to increase the hand positions and painted to improve grip.
- Resistive polyethylene pedal, designed to make pedalling smoother and more effective.
- Excellent stability, ensured by the perfect balance between front and rear axes, well-sized bases and four suction cups in transparent PVC.
- The 74° seat-handlebar angle ensures the best position during use, excluding horizontal seat adjustments.
- The front wheels facilitate the movement of the bike when exiting the water and on the poolside.

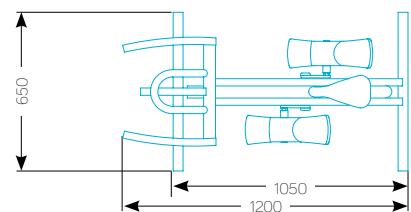
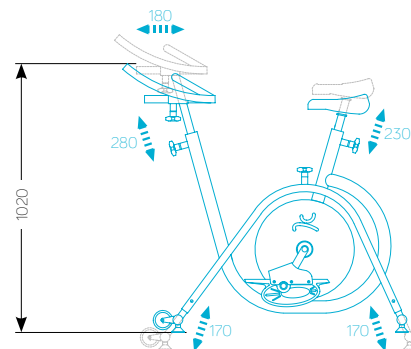

**ACTIVE AQUABIKE**  
cod. AFA 0002 PRW mod. **ACCIAIO**  
cod. AFA 0002 N PRW mod. **BLACK**



Carter colorato e pedale con alloggiamento piede in Eva Foam  
Coloured case and new foot rest in Eva Foam

## SMART UP AQUABIKE

- + EXCLUSIVE ITALIAN DESIGN, MADE IN ITALY
- + INGOMBRO E PESO CONTENUTI  
COMPACT SIZE AND LOW WEIGHT
- + ALLOGGIO PIEDE CONFORTEVOLE  
COMFORTABLE PEDAL COVER
- + PRODOTTO MARCHIATO CE  
CE MARKED PRODUCT
- + BASE EXTRALONG (OPZIONALE)  
EXTRA LONG BASE (OPTIONAL)

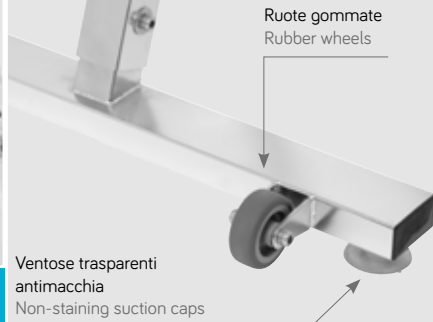

Ordinabile anche in versione Long  
Also available in the Long version

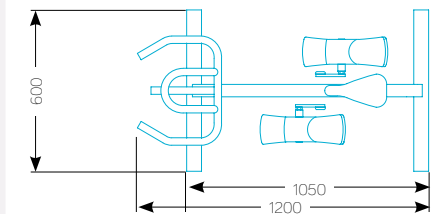
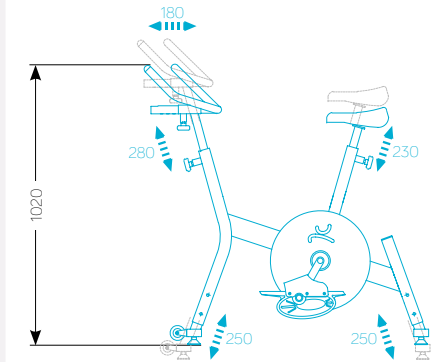

White

Yellow

Lime

Orange

## AQX AQUABIKE

- + AQUABIKE MADE IN ITALY
- + ACCESSORI AGGIUNTIVI  
ADDITIONAL ACCESSORIES
- + SMILE PRICE BIKE
- + PEDALE RESISTIVO  
RESISTIVE PEDAL
- + PESO E INGOMBRO CONTENUTI  
COMPACT SIZE AND LOW WEIGHT
- + ALLOGGIO PIEDE CONFORTEVOLE  
COMFORTABLE FOOT HOLDER



Ordinabile anche mod. Full Optional  
Full Optional model also available

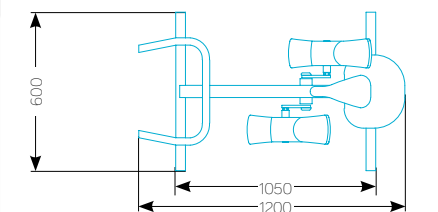
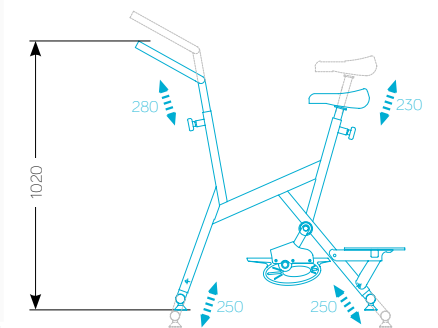



**EAA INSTRUCTOR TRAININGS:**Master **AQUABIKE**Master **AQUA CIRCUIT**Master **AQUAxFIT®**Course **AQUA PERSONAL PROGRAM****mod. SMART UP + LONG SMART UP**

<b>Materiale</b> Material	Inox AISI 316L 316 L stainless steel
<b>Profondità d'impiego</b> Depth of use	<b>SMART UP</b> 100 - 140 cm <b>L SMART UP</b> 100 - 180 cm
<b>Peso</b>	AFA 0013 019 21 kg
<b>Weight</b>	AFA 0015 019 23 kg

**mod. AQX + AQX FULL OPTIONAL**

<b>Materiale</b> Material	Inox AISI 304 304 stainless steel
<b>Profondità d'impiego</b> Depth of use	100 - 140 cm
<b>Peso</b>	AFA AQX 001 14 kg
<b>Weight</b>	AFA AQX 001 FO 16 kg

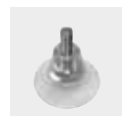
**QUALI VENTOSE SCEGLIERE?  
WHICH KIND OF SUCTION CUP?**

**AFA RGEN 003**  
consigliata per vasche con **SUPERFICI LISCE** (pvc liscio, ceramica liscia...) suggested for SMOOTH SURFACE pools (smooth pvc, smooth ceramic...)



**AFA RGEN A03**  
consigliata per vasche con **SUPERFICI SEMI RUVIDE O IRREGOLARI** (mosaico, inox bugnato, ceramica ruvida, pvc ruvido...) suggested for UNEVEN OR IRREGULAR SURFACE pools (mosaic, embossed stainless steel, rough ceramic ruvida, rough pvc...)

SMART AQUABIKE è la soluzione per chi necessita di un prodotto di qualità, ma ideato per utilizzi meno intensivi, come stagionali o target più giovane.

- Carter colorato, in 4 varianti, che valorizza l'estetica oltre a garantirne la sicurezza attiva durante la pedalata.
- Sistema di resistenza determinato dal pedale resistivo, con nuovo alloggiamento del piede in Eva Foam per una confortevole calzata, anche a piede nudo.
- Telaio con profilati quadrati.
- Stabilità e solidità assicurano affidabilità e ridottissima manutenzione.
- Regolazione verticale di sella e manubrio: esaustive per comfort in uso grazie all'angolo di 74° del telaio (*esclusiva Acquatix*)
- **Opzionale: sistema di regolazione dell'altezza per vasche fino a 180 cm.**

SMART AQUABIKE is the ideal solution for those who need a quality product, but it is also designed for less intensive uses, aimed at seasonal clients or a younger target public.

- Coloured carter, in 4 variants, which enhances the aesthetics as well as ensuring active safety during pedalling.
- Resistance system determined by the resistive pedal, with new Eva Foam foot rest to ensure a comfortable fit, even with bare feet.
- Frame with square profiles.
- Stability and solidity ensure reliability and very low maintenance.
- Vertical saddle and handlebar adjustment: ensuring comfortable use thanks to the 74° angle of the frame (*Acquatix exclusive*)
- **Optional: height adjustment system for pools up to 180 cm deep.**

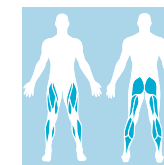
**MODELLO PRODOTTO SOLO SU RICHIESTA:  
minimo quantitativo 50 pz.**

Aquabike stazionaria dalla linea essenziale, solida e versatile, realizzata nelle versioni **Standard** e **Full Optional**.

- Dimensioni ridotte per gestire al meglio gli spazi
- Pedale resistivo per una pedalata più fluida ed efficace, con confortevole alloggiamento del piede in gomma.
- L'angolo sella-manubrio di 74°, assicura la miglior posizione nell'utilizzo escludendo regolazioni orizzontali della sella.
- Full Optional: accessori che permettono di ampliare la gamma di esercizi.

**MODEL EXCLUSIVELY ON REQUEST:  
minimum quantity of 50 pieces**

Stationary Aquabike with essential lines, solid and versatile, comes in both a **Standard** and a **Full Optional** version.

- Small size to better manage spaces
- Resistive pedal designed to make pedalling smoother and more effective, with comfortable rubber foot rest.
- The 74° saddle-handlebar angle ensures the best position during use excluding horizontal saddle adjustments.
- Full Optional: accessories that allow you to expand the range of exercises.

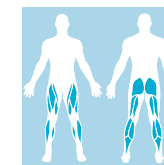
**SMART UP AQUABIKE**cod. AFA 0013 019 mod. **STANDARD**cod. AFA 0015 019 mod. **LONG****AQX AQUABIKE**cod. AFA AQX 001 mod. **STANDARD**cod. AFA AQX 001 FO mod. **FULL OPTIONAL**

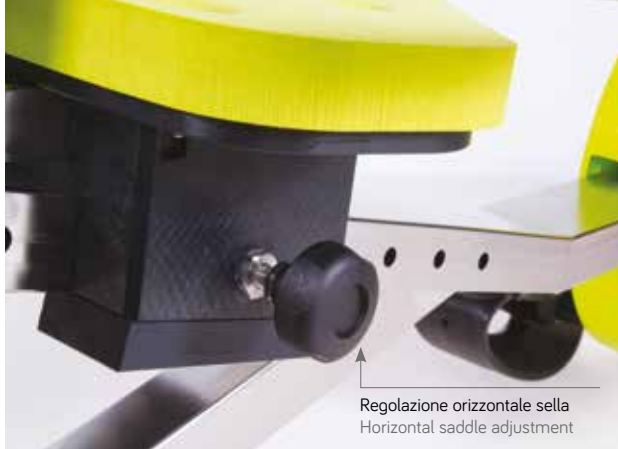

## GALAXY AQUABIKE

- + AQUABIKE MADE IN ITALY
- + EXCLUSIVE ITALIAN DESIGN
- + INGOMBRI RIDOTTI  
REDUCED OBSTRUCTION
- + SISTEMA REGOLAZIONE INTENSITÀ  
INTENSITY REGULATION SYSTEM
- + REGOLAZIONE ORIZZONTALE DA SEDUTI  
SEAT ADJUSTMENT
- + IDEALE PER VASCHE MOLTO BASSE  
IDEAL FOR SHALLOW POOLS
- + PRODOTTO MARCHIATO CE  
CE MARKED PRODUCT





### EAA INSTRUCTOR TRAININGS:

Master **AQUA CIRCUIT**

Course **AQUA PERSONAL PROGRAM**



<b>Materiale</b> Material	Inox AISI 316L 316 L stainless steel
<b>Profondità d'impiego</b> Depth of use	70 - 100 cm
<b>Intensità pedalata</b> Cycling intensity	Regolabile Adjustable
<b>Peso</b> Weight	21 kg

### QUALI VENTOSE SCEGLIERE? WHICH KIND OF SUCTION CUP?



**AFA RGEN 003**  
consigliata per vasche con **SUPERFICI LISCE** (pvc liscio, ceramica liscia...)  
suggested for **SMOOTH SURFACE** pools  
(smooth pvc, smooth ceramic...)



**AFA RGEN A03**  
consigliata per vasche con **SUPERFICI SEMI RUVIDE O IRREGOLARI**  
(mosaico, inox bugnato, ceramica ruvida, pvc ruvido...)  
suggested for **UNEVEN OR IRREGULAR SURFACE** pools  
(mosaic, embossed stainless steel, rough ceramic ruvida, rough pvc...)

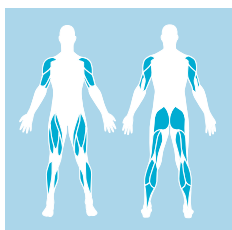

GALAXY è l'Aquabike orizzontale ideata dal centro R&D di Aquatix per vasche di profondità contenuta tra 70-100 cm.

- Pensata per facilitare il training di chi ha patologie lombari o necessita progressivamente di attivare gli arti inferiori.
- Ottima per qualsiasi persona e per un allenamento completo (attivando anche le braccia), giovandosi della quasi completa immersione del busto, come non è possibile con le Aquabike verticali.
- Indicata anche per circuiti e percorsi/protocolli riabilitativi.
- Pedale resistivo in polietilene, dal design studiato per rendere più fluida ed efficace la pedalata.

GALAXY is the horizontal Aquabike created by the Aquatix R&D Centre for pools 70-100 cm deep.

- Designed to facilitate the training of people with lumbar pathologies or who need to progressively activate their lower limbs.
- Excellent for any person and for a complete workout (it also activates the arms), taking advantage of the almost complete immersion of the torso, which is not possible with vertical Aquabikes.
- Also suitable for rehabilitation circuits and routes/protocols.
- Resistive polyethylene pedal, designed to make pedalling smoother and more effective.

## GALAXY AQUABIKE

cod. AFA 0801 PRW

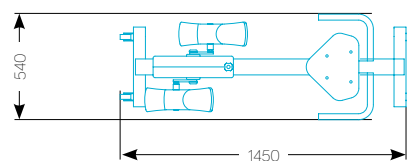
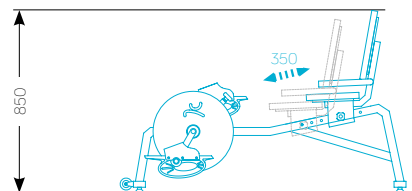

# AQUABIKES



**Optional**  
Su richiesta | On request

Sinistra AFA RPED SNL  
Destra AFA RPED SNR  
**Pedale Neoprene**  
Neoprene Pedal

BAQ 0001  
**Borraccia**  
Bottle

BAQ 0002  
**Porta Borraccia**  
Bottle Cage

AFA RGEN A03  
**Ventosa blu**  
Blue suction cap

BPM AFA RBPM L04  
Smart AFA 0015 019  
**Prolunga altezza**  
Length ext.

AFA AQX 002  
**Step posteriore**  
Rear step

AFA AQX 003  
**Manubrio post.**  
Rear handlebar

AFA 0400  
**Elastici**  
Elastics

AFO 0300  
**Parabordo**  
Board guard

AFO PEA  
**Pedane in inox**  
Platforms

AFA BPM 002 <b>BPM AQUABIKE TWO</b>	✓	✓	✓	✓	✓	-	-	✓*	✓	✓
AFA 0002 PRW   AFA 0002 N PRW <b>ACTIVE AQUABIKE</b>	✓	✓	✓	✓	-	-	-	✓*	✓	✓
AFA 0013 019 <b>SMART UP AQUABIKE</b>	✓	✓	✓	✓	✓	-	-	✓*	✓	✓
AFA AQX 001   AFA AQX 001 FO <b>AQX AQUABIKE</b>	✓	✓	✓	✓	-	✓	✓	✓	✓	✓
AFA 0801 PRW <b>GALAXY AQUABIKE</b>	✓	-	-	✓	-	-	-	-	-	✓

\*È necessario aggiungere Vite con Anello, cod. AFA RGEN 072 | \* it is necessary to add Screw Eyes, cod. AFA RGEN 072

<b>Dettagli</b> Tecnici   Technical		Materiale Material	Ingombro minimo Minimum bulk	Profondità d'impiego Depth of use	Intensità pedalata Cycling intensity	Peso Weight
AFA BPM 002 <b>BPM AQUABIKE TWO</b>		Polietilene, Inox 316 L Polyethylene, st. 316 L	1050 x 650 mm	100 - 140 cm	Regolabile Adjustable	26 kg
AFA 0002 PRW   AFA 0002 N PRW <b>ACTIVE AQUABIKE</b>		Inox AISI 316L Stainless steel 316 L	1050 x 650 mm	100 - 140 cm	Regolabile Adjustable	22,5 kg
AFA 0013 019   AFA 0015 019 <b>SMART UP AQUABIKE</b>		Inox AISI 316L Stainless steel 316 L	1050 x 600 mm	100 - 140 cm 140 - 180 cm	-	21 kg
AFA AQX 001   AFA AQX 001 FO <b>AQX AQUABIKE</b>		Inox AISI 304 L Stainless steel 316 L	1050 x 600 mm	100 - 130 cm	-	14 kg   16 kg
AFA 0801 PRW <b>GALAXY AQUABIKE</b>		Inox AISI 316L Stainless steel 316 L	1450 x 540 mm	70 - 100 cm	Regolabile Adjustable	21 kg

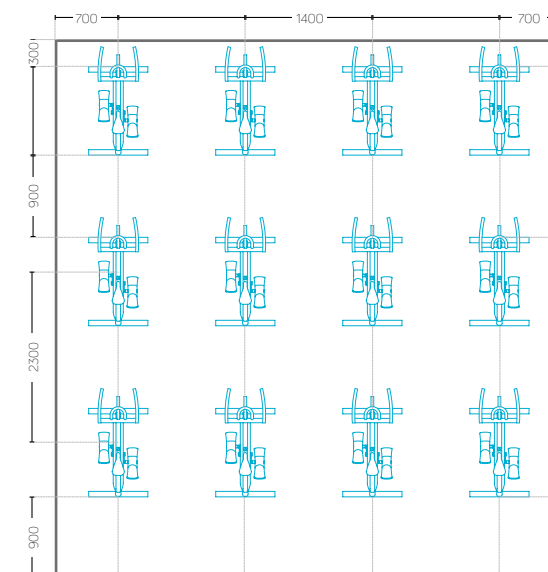



AQUATREADMILLS



Il sistema di scorrimento del nastro a tre rulli di **STAR AQUATREADMILL** garantisce la massima fluidità e scorrevolezza: è l'unico che consente la corsa in acqua

The STAR AQUATREADMILL three-roll sliding system guarantees maximum fluidity and smoothness: it is the only kind that allows running in the water



## STAR AQUATREADMILL

- + TREADMILL MADE IN ITALY
- + EXCLUSIVE ITALIAN DESIGN
- + SCOCCA IN POLIETILENE  
POLYETHYLENE SHELL
- + OTTIMO SCORRIMENTO DEL NASTRO  
EXCELLENT BELT SLIDING
- + AMPIA PEDANA LATERALE  
LARGE LATERAL FOOTBOARD
- + PRODOTTO MARCHIATO CE  
CE MARKED PRODUCT
- + NUOVO COLORE "LIME"  
NEW COLOUR "LIME"





**EAA**  
EUROPEAN AQUATIC ASSOCIATION

### EAA INSTRUCTOR TRAININGS:

Master **AQUA TREADMILL**

Master **AQUA CIRCUIT**

Master **AQUAxFIT®**

Course **AQUA PERSONAL PROGRAM**



<b>Materiale</b> Material	Polietilene Inox AISI 316L
<b>Profondità d'impiego</b> Depth of use	100 - 140 cm
<b>Inclinazione pedana</b> Slope	13°
<b>Peso</b> Weight	28 kg

### QUALI VENTOSE SCEGLIERE? WHICH KIND OF SUCTION CUP?



**AFA RGEN 003**  
consigliata per vasche con **SUPERFICI LISCE** (pvc liscio, ceramica liscia...) suggested for **SMOOTH SURFACE** pools (smooth pvc, smooth ceramic...)



**AFA RGEN A03**  
consigliata per vasche con **SUPERFICI SEMI RUVIDE O IRREGOLARI** (mosaico, inox bugnato, ceramica ruvida, pvc ruvido...) suggested for **UNEVEN OR IRREGULAR SURFACE** pools (mosaic, embossed stainless steel, rough ceramic ruvida, rough pvc...)

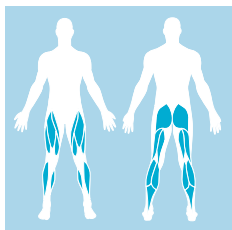

STAR Aquatreadmill è un tapis roulant meccanico, in polietilene, studiato per aqua walking e aqua running.

- Coniuga innovazione, design, funzionalità e praticità.
- Nato per walking e running in acqua, è ideale per attività con classi di allievi coordinate da istruttore, ma anche per riabilitazione e sedute mirate e personalizzate di training in acqua.
- Unico per stabilità, affidabilità e scorrevolezza del nastro.
- Compatto in chiusura, è agevolmente movimentabile sul piano vasca.
- Materiali idonei anche in caso di prolungati periodi di immersione.

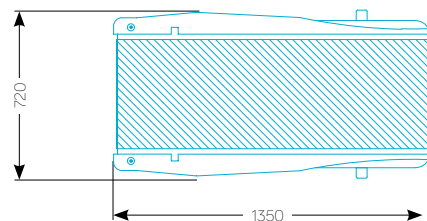
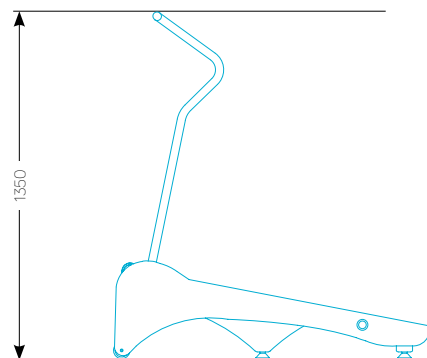
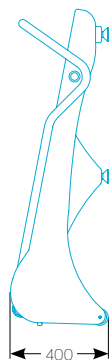

STAR Aquatreadmill is a mechanical treadmill, in polyethylene, designed for aqua walking and aqua running.

- It seamlessly combines innovation, design, functionality and practicality.
- Created for walking and running in the water, it is ideal for activities involving classes of students coordinated by an instructor, but also for rehabilitation and targeted and personalized training sessions in the water.
- Unique in terms of stability, reliability and smooth running of the belt.
- Compact when closed, it can be easily moved around the pool area.
- Materials suitable for prolonged periods of time in the water.

## STAR AQUATREADMILL

cod. AFA 0012





Chiusura di sicurezza  
Safety lock



Piccolo, pratico e maneggevole,  
**STANDARD AQUATREADMILL**  
garantisce una vasta gamma di esercizi.  
Small, practical and handy,  
**STANDARD AQUATREADMILL**  
guarantees a wide range of exercises.

Rulli scorrimento nastro  
Belt rollers

## STANDARD AQUATREADMILL

- + TREADMILL MADE IN ITALY
- + EXCLUSIVE ITALIAN DESIGN
- + ADATTO AD ACQUE TERMALI O SALATE  
SUITABLE FOR THERMAL OR SALT WATER
- + APPOGGIO LATERALE PER PIEDE  
SIDE FOOT REST
- + INGOMBRO RIDOTTO  
REDUCED OBSTRUCTION
- + PRODOTTO MARCHIATO CE  
CE MARKED PRODUCT

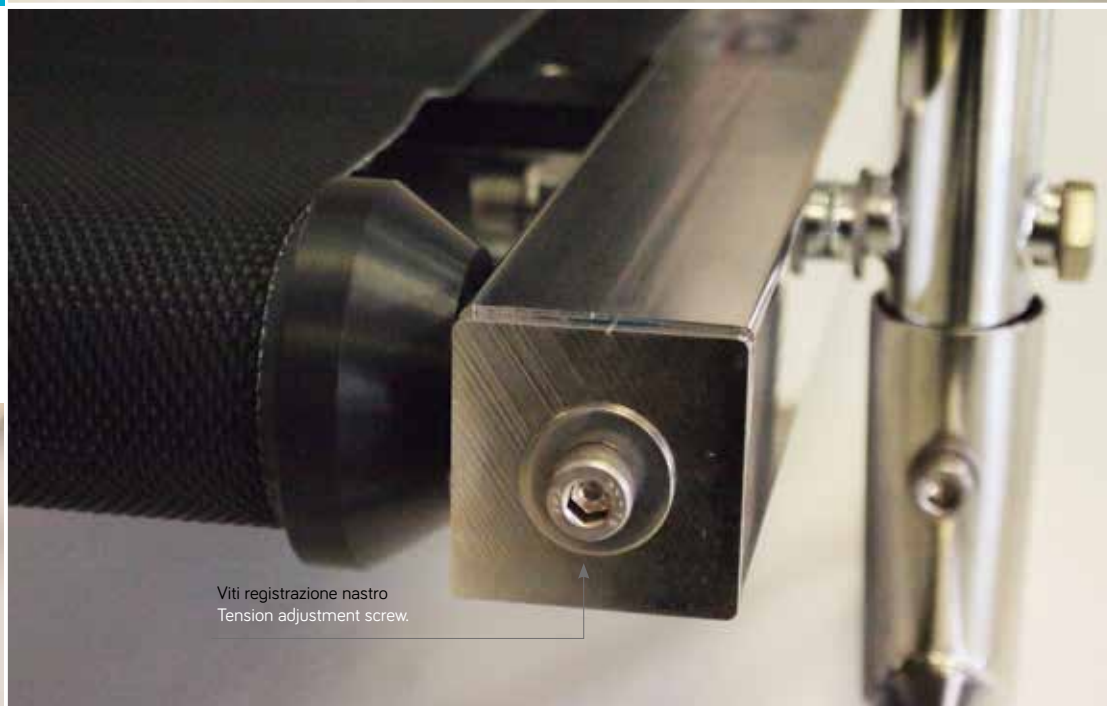

Viti registrazione nastro  
Tension adjustment screw.







### EAA INSTRUCTOR TRAININGS:

Master [AQUA TREADMILL](#)

Master [AQUA CIRCUIT](#)

Master [AQUAxFIT®](#)

Course [AQUA PERSONAL PROGRAM](#)



<b>Materiale</b> Material	Inox AISI 316L 316 L stainless steel
<b>Profondità d'impiego</b> Depth of use	100 - 120 cm
<b>Inclinazione pedana</b> Slope	13°
<b>Peso</b> Weight	20 kg

### QUALI VENTOSE SCEGLIERE? WHICH KIND OF SUCTION CUP?



**AFA RGEN 003**  
consigliata per vasche con **SUPERFICI LISCE** (pvc liscio, ceramica liscia...) suggested for SMOOTH SURFACE pools (smooth pvc, smooth ceramic...)



**AFA RGEN A03**  
consigliata per vasche con **SUPERFICI SEMI RUVIDE O IRREGOLARI** (mosaico, inox bugnato, ceramica ruvida, pvc ruvido...) suggested for UNEVEN OR IRREGULAR SURFACE pools (mosaic, embossed stainless steel, rough ceramic ruvida, rough pvc...)

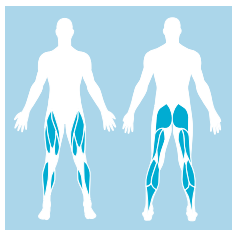

STANDARD Aquatreadmill è un tapis roulant meccanico studiato per aqua walking e aqua running.

- Ideale per attività con classi di allievi coordinate da istruttore.
- Dimensioni più contenute e peso più leggero rendono questo modello molto pratico e ideale in vasche di piccole dimensioni.
- Materiali idonei anche in caso di prolungati periodi di immersione.

STANDARD Aquatreadmill is a mechanical treadmill designed for aqua walking and aqua running.

- Ideal for activities involving classes of students coordinated by an instructor.
- Smaller dimensions and lighter weight make this model very practical and ideal for small pools.
- Resistant materials, suitable for prolonged periods of time in the water.

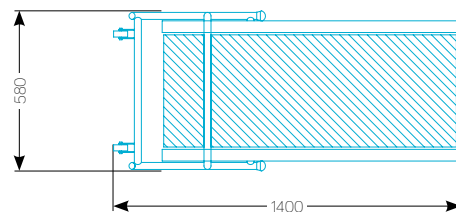
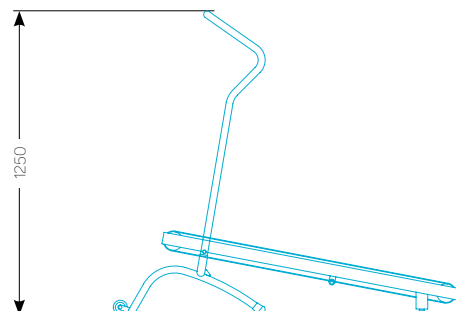
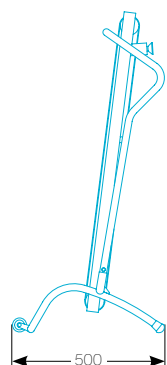

## STANDARD AQUATREADMILL

cod. AFA 0014

# AQUATREADMILL



**Optional**  
Su richiesta | On request

BAQ 0001  
**Borraccia**  
Bottle

BAQ 0002  
**Porta Borraccia**  
Bottle Cage

AFA RGEN A03  
**Ventosa blu**  
Blue suction cap

AFO 0300  
**Parabordo**  
Board guard

AFO PEA  
**Pedane in inox**  
Platforms

AFA 0012 <b>STAR AQUATREADMILL</b>	✓	✓	✓	✓	✓
AFA 0014 <b>STANDARD AQUATREADMILL</b>	✓	✓	✓	✓	✓

**Dettagli**  
Tecnici | Technical

	Materiale Material	Ingombro minimo Minimum bulk	Profondità d'impiego Depth of use	Inclinazione Slope	Peso Weight
AFA 0012 <b>STAR AQUATREADMILL</b>	Polietilene, Inox 316 L Polyethylene, st. 316 L	1350 x 820 mm	100 - 140 cm	13°	28 kg
AFA 0014 <b>STANDARD AQUATREADMILL</b>	Inox AISI 316L Stainless steel 316 L	1400 x 580 mm	100 - 120 cm	13°	20 kg

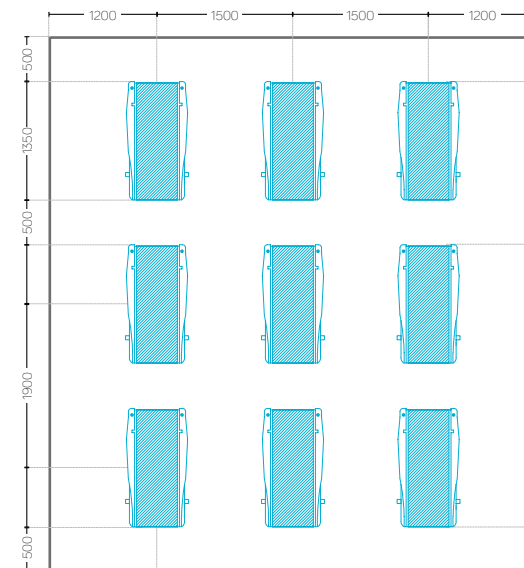

# Circuit examples

DISPOSIZIONE A RETTANGOLO  
RECTANGLE DISPOSITION

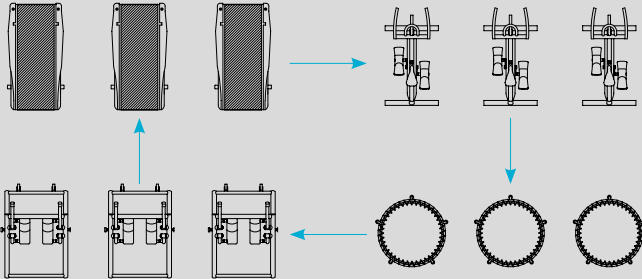

Questi sono solo alcuni esempi di circuiti e possono essere proposti con altri grandi e piccoli attrezzi

DISPOSIZIONE A X  
X DISPOSITION

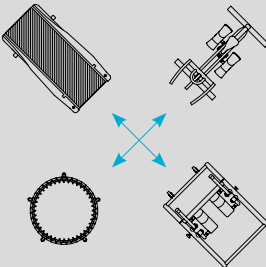

DISPOSIZIONE A Z  
Z DISPOSITION

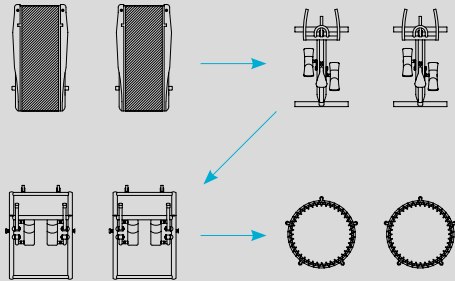

DISPOSIZIONE A MEZZA CLASSE  
DIVIDING THE CLASS INTO TWO GROUPS IN THE POOL

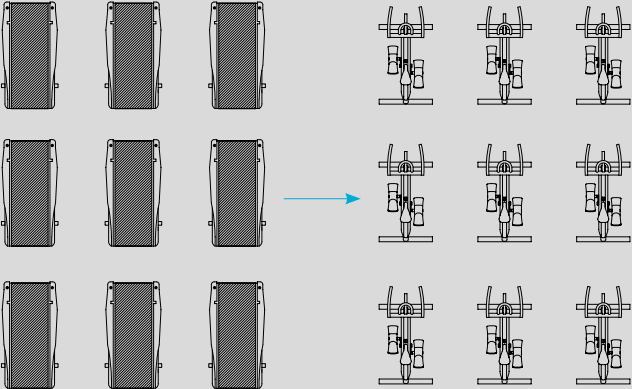

These are just a few examples of circuits and they can be prepared using other tools, both big and small



## MOON WALKER

- + EXCLUSIVE ITALIAN DESIGN, MADE IN ITALY
- + SEMPLICE MODULARITÀ DEI CARICHI  
SIMPLE ADJUSTMENT OF LOADS
- + MASSIMA STABILITÀ E SICUREZZA  
MAXIMUM STABILITY AND SAFETY
- + SIMULAZIONE DI DEAMBULAZIONE "GUIDATA"  
"GUIDED" WALKING SIMULATION
- + TRAINING E RECUPERO FUNZIONALE  
TRAINING AND FUNCTIONAL RECOVER
- + PRODOTTO MARCHIATO CE  
CE MARKED PRODUCT



Chiusura di sicurezza  
Safety lock



Impugnatura  
Handle



Ventose trasparenti antimacchia  
Non-staining suction caps



Alloggio piede in neoprene, rinforzato  
Reinforced neoprene shoe

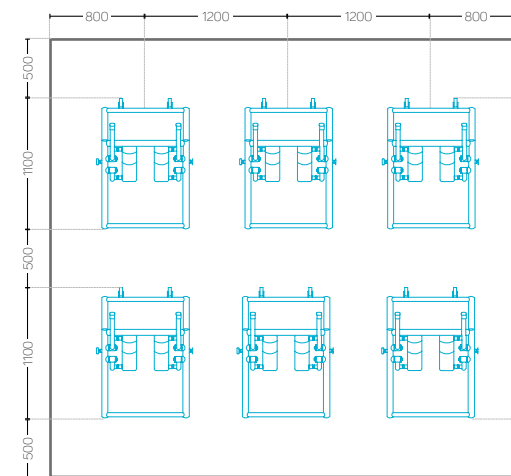



**EAA**  
EUROPEAN AQUATIC ASSOCIATION

### EAA INSTRUCTOR TRAININGS:

Master **AQUA CIRCUIT**

Master **AQUAxFIT®**

Course **AQUA PERSONAL PROGRAM**



**Materiale**  
Material

Inox AISI 316L  
316L stainless steel

**Profondità d'impiego**  
Depth of use

100 - 140 cm

**Peso**  
Weight

26 kg

### QUALI VENTOSE SCEGLIERE? WHICH KIND OF SUCTION CUP?



**AFA RGEN 003**  
consigliata per vasche con **SUPERFICI LISCE** (pvc liscio, ceramica liscia...) suggested for **SMOOTH SURFACE** pools (smooth pvc, smooth ceramic...)



**AFA RGEN A03**  
consigliata per vasche con **SUPERFICI SEMI RUVIDE O IRREGOLARI** (mosaico, inox bugnato, ceramica ruvida, pvc ruvido...) suggested for **UNEVEN OR IRREGULAR SURFACE** pools (mosaic, embossed stainless steel, rough ceramic ruvida, rough pvc...)

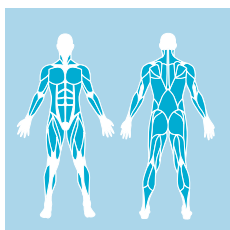

MOON WALKER è un attrezzo multifunzione che riproduce il movimento ispirato al Nordic Walking, ma in condizioni di parziale gravità dovuta all'immersione.

- Permette di allenare contemporaneamente gambe e braccia.
- Efficace anche nell'impiego dei soli arti superiori, che possono accompagnare il movimento delle gambe o essere attivi nello sforzo.
- Attrezzo costruito con materiale idoneo a rimanere in acqua per lungo periodo.

MOON WALKER is a multifunctional equipment that reproduces a form of walking or running in less gravity, a movement inspired by Nordic Walking.

- Allows simultaneous training of legs and arms.
- Also effective in the use of only the upper limbs, which may accompany the movement of the legs or be active in the effort.
- Resistant materials, suitable for prolonged periods of time in the water.

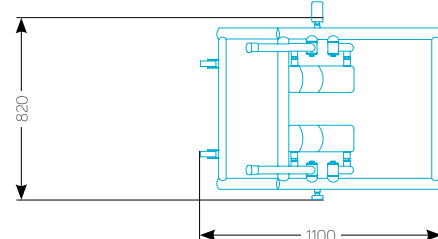
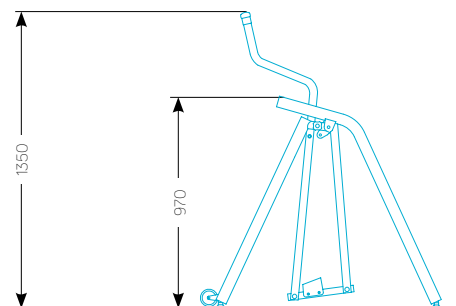
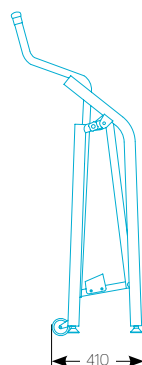

CE



## MOON WALKER

cod. AFA 0150 mod. **ACCIAIO**

cod. AFA 0150 N mod. **BLACK**

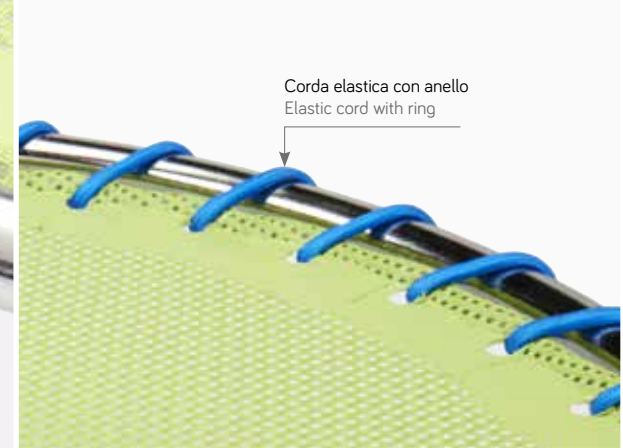
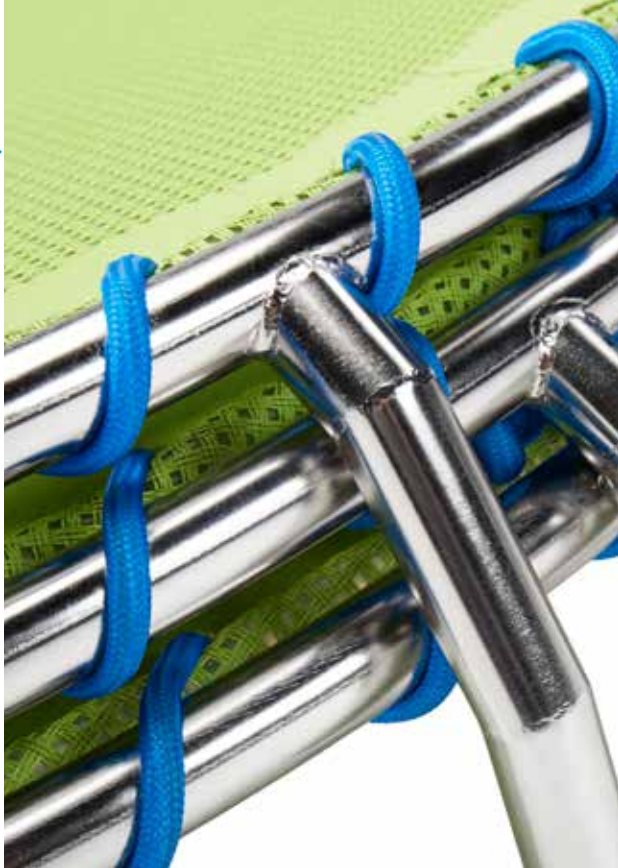

## ROUND JUMP

- + JUMP MADE IN ITALY
- + EXCLUSIVE ITALIAN DESIGN
- + AMPIA AREA DI LAVORO  
LARGE WORKING AREA
- + IMPILABILE A BORDO VASCA  
CAN BE STACKED ON POOL SIDE
- + OTTIMA RISPOSTA ELASTICA DEL TELO  
EXCELLENT MAT ELASTICITY





### EAA INSTRUCTOR TRAININGS:

Master **AQUA STEP & JUMP**

Master **AQUA CIRCUIT**

Master **AQUAxFIT®**

Course **AQUA PERSONAL PROGRAM**



Materiale Material	Inox AISI 316L 316L stainless steel
Profondità d'impiego Depth of use	100 - 150 cm
Ventose Suction cup	5
Peso Weight	5 kg

### QUALI VENTOSE SCEGLIERE? WHICH KIND OF SUCTION CUP?



**AFA RGEN 003**  
consigliata per vasche con **SUPERFICI LISCE** (pvc liscio, ceramica liscia...)  
suggested for **SMOOTH SURFACE** pools  
(smooth pvc, smooth ceramic...)



**AFA RGEN A03**  
consigliata per vasche con **SUPERFICI SEMI RUVIDE O IRREGOLARI**  
(mosaico, inox bugnato, ceramica ruvida, pvc ruvido...)  
suggested for **UNEVEN OR IRREGULAR SURFACE** pools  
(mosaic, embossed stainless steel, rough ceramic ruvida, rough pvc...)

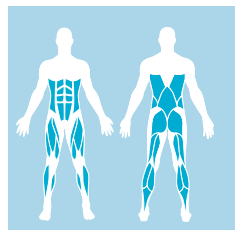

ROUND JUMP è un attrezzo resistente e leggero, ottimo per attività in acqua.

- Ideale per lezioni di fitness in acqua generiche, di gruppo, ma anche in ottica di preparazione atletica e rieducazione funzionale.
- Minimo ingombro di più attrezzi fuori dall'acqua.

ROUND JUMP is a lightweight and strong workout gear, excellent for water activities.

- Ideal for aquafitness, group classes, for aquatraining or functional rehabilitation and athletic training targeted.
- It takes a minimal amount of space out of the water.

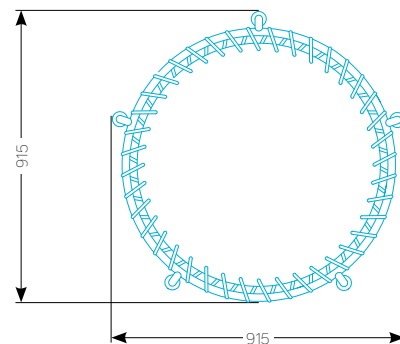
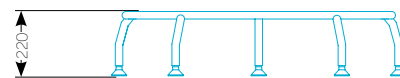

## ROUND JUMP

cod. AFA 0603





Comoda impugnatura in acciaio  
Stainless steel handlebar



6 Ventose a super tenuta  
6 special suction caps



3 diverse altezze per  
gli esercizi delle gambe  
3 different heights for  
leg exercises

## WATER UP & DOWN

- + FACILE E VERSATILE  
EASY AND ADAPTABLE
- + DIVERSE ALTEZZE E PIANI DI MOVIMENTO  
SEVERAL HEIGHTS AND MOVEMENT SURFACES
- + INNUMEREVOLI ESERCIZI  
COUNTLESS EXERCICES
- + UTILIZZO IN COPPIA  
USED IN PAIRS
- + ADATTO A QUALSIASI ALLIEVO  
SUITABLE TO ALL LEARNERS







### EAA INSTRUCTOR TRAININGS:

Master **WATER UP & DOWN - ON DEMAND**

Master **AQUA CIRCUIT**

Master **AQUAxFIT®**

Course **AQUA PERSONAL PROGRAM**



Materiale Material	Inox AISI 316L 316L stainless steel
Profondità d'impiego Depth of use	100 - 120 cm
Peso Weight	7 kg

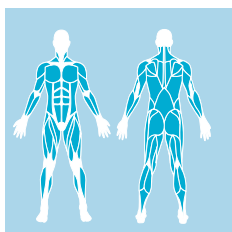

### Articolo prodotto solo su richiesta.

WATER UP & DOWN è un attrezzo acquatico di facile impiego.

La sua versatilità ne consente l'utilizzo per l'aquafitness classica, ma anche in contesti più specifici come rieducazione funzionale, attività per disabili e corsistica per ragazzi.

### Model exclusively on request.

WATER UP & DOWN is a water equipment very easy to use. It can be used for general aquafitness, but also in more specific fields, such as rehabilitation, activities for disabled people and childrens courses.

## WATER UP & DOWN

cod. AFA UPD 001

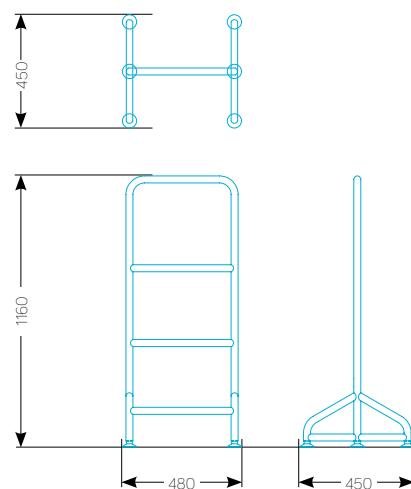

**MOON WALKER  
ROUND JUMP  
WATER UP & DOWN**



BAQ 0001  
**Borraccia**  
Bottle



BAQ 0002  
**Porta Borraccia**  
Bottle Cage



AFA RGEN A03  
**Ventosa blu**  
Blue suction cap



AFO 0300  
**Parabordo**  
Board guard



AFO PEA  
**Pedane in inox**  
Platforms

**Optional**  
Su richiesta | On request

AFA 0150   AFA 0150 N <b>MOON WALKER</b>	-	-	✓	✓	✓
AFA 0603 <b>ROUND JUMP</b>	-	-	✓	-	✓
AFA UPD 001 <b>WATER UP &amp; DOWN</b>	✓	✓	articolo di serie standard article	-	✓



**Dettagli**  
Tecnici | Technical

	Materiale Material	Ingombro minimo Minimum bulk	Profondità d'impiego Depth of use	Peso Weight	Persone Users
AFA 0150   AFA 0150 N <b>MOON WALKER</b>	Inox AISI 316L Stainless steel 316L	820 x 1100 mm	100 - 140 cm	26 kg	1
AFA 0603 <b>ROUND JUMP</b>	Inox AISI 316L Stainless steel 316L	915 x 915 mm	100 - 140 cm	5 kg	1
AFA UPD 001 <b>WATER UP &amp; DOWN</b>	Inox AISI 316L Stainless steel 316L	480 x 450 mm	100 - 120 cm	7 kg	2

FLOAT2FITNESS



**4 STAZIONI ANGOLARI** esterne per una massima differenziazione  
4 external CORNER STATIONS for maximum differentiation



**T-BAR**  
Stazione di allenamento braccia e dorsali con barra trazioni  
T-BAR arm and back training station with pull-up bar



**STAZIONE SINGOLA**  
altezza regolabile per aggancio di un elastico  
SINGLE STATION with adjustable height for hooking on one resistance band



## FLOAT2FITNESS

- + EXCLUSIVE DESIGN MADE IN ITALY
- + ATTREZZO POLIVALENTE  
MULTI-PURPOSE EQUIPMENT
- + SOLUZIONE MODULARE  
MODULAR SOLUTION
- + PALESTRA GALLEGGIANTE  
FLOATING GYM
- + UTILIZZO SIMULTANEO FINO A 8 PERSONE  
MULTIPLE USE FOR UP TO 8 PEOPLE
- + CIRCUIT TRAINING, RECUPERO FUNZIONALE E PREPARAZIONE ATLETICA  
CIRCUIT TRAINING, FUNCTIONAL RECOVERY AND ATHLETIC PREPARATION
- + NUOVI ACCESSORI  
NEW ACCESSORIES

**SEDILE** con altezza regolabile per modulare correttamente la posizione in acqua  
SEAT with adjustable height to correctly modulate the position in water



**STAZIONE** con altezza regolabile e possibilità di aggancio di 6 elastici  
STATION with adjustable height and 6 rings for hooking on resistance bands

**Optional**  
Su richiesta | On request

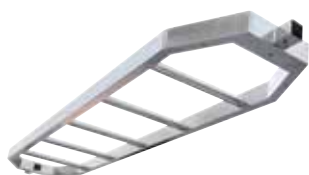

AFA FLO 0002  
**SCALA ORIZZONTALE** necessaria per l'unione di 2 Float2Fitness  
**HORIZONTAL LADDER** necessary for connecting 2 Float2Fitness

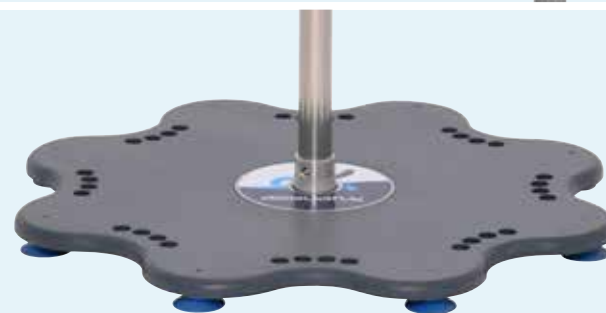

**BASE** in pvc con asta verticale prodotta su misura in base alla profondità della vasca  
PVC BASE with a vertical rod custom made according to the depth of the pool

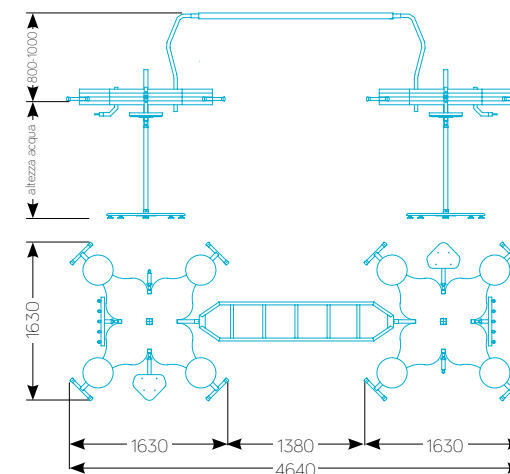



**EAA**  
EUROPEAN AQUATIC ASSOCIATION

**EAA INSTRUCTOR TRAINING:**  
ON DEMAND F2F Training Method



**Materiale**  
Material

Eva 100 + Pvc + Inox  
AISI 316L stainless st.

**Profondità d'impiego**  
Depth of use

> 110 cm

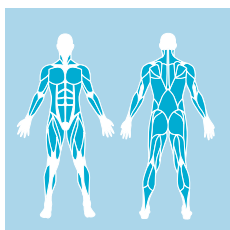
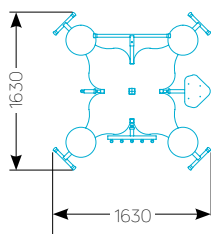
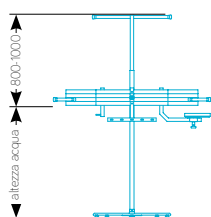

Attrezzo innovativo e modulare, FLOAT2FITNESS è una palestra galleggiante che porta il concetto del fitness in acqua a un livello superiore. Con possibilità di creare percorsi di allenamento funzionale in modo facile, rapido e divertente, F2F è stata sviluppata per soddisfare non solo il pubblico del fitness acquatico, ma anche quello sportivo e riabilitativo, grazie all'abbinamento di attrezzi e accessori intercambiabili a beneficio della qualità dell'esercizio effettuato. Ciascun modulo F2F è quindi fruibile da 8 persone contemporaneamente. Agganciando tra loro due moduli, con accessorio opzionale - Scala Orizzontale - è possibile creare un circuito dalle dimensioni e potenzialità maggiori.

**Il modulo base di FLOAT2FITNESS dispone di:**

- 1 asta con base di ancoraggio al fondo
- 1 seduta per workout gambe e addome
- 1 attacco per elastici mono posizione
- 1 attacco per elastici a 6 posizioni
- 1 Kit Accessori
- 1 T-bar per trazioni delle braccia
- 4 stazioni angolari esterne per un core training dinamico e divertente.

The basic FLOAT2FITNESS module has:

- 1 rod with anchoring base at the bottom
- 1 seating support for leg and abdomen workout
- 1 attachment for single position elastics
- 1 attachment for 6-position elastics
- 1 Accessory Kit
- 1 T-bar for arm pulls
- 4 external corner stations for dynamic and fun core training.



**KIT ACCESSORI**

- 2 maniglie in neoprene
- 1 cavigliera con chiusura velcro
- 2 elastici STRONG + 2 moschettoni
- 2 elastici MEDIUM + 2 moschettoni
- 1 Cintura

**ACCESSORY KIT**

- 2 neoprene handles
- 1 anklet with velcro straps
- 2 STRONG elastic bands + 2 karabiners
- 2 MEDIUM elastics + 2 karabiners
- 1 Belt

**Colori: soggetti a disponibilità di magazzino**  
Colours: subject to availability

An innovative and modular device, FLOAT2FITNESS is a floating gym that takes the concept of fitness in the water to a new level. With the possibility of creating functional training courses in an easy, quick and fun way, F2F has been developed to satisfy not only the aquatic fitness public, but also those focused on sports and rehabilitation, thanks to a combination of interchangeable tools and accessories that enhance the quality of the exercise being carried out. Each F2F module can be used by 8 people simultaneously. By hooking two modules together, using an optional accessory - Horizontal Ladder - a circuit with greater dimensions and potential can be created.

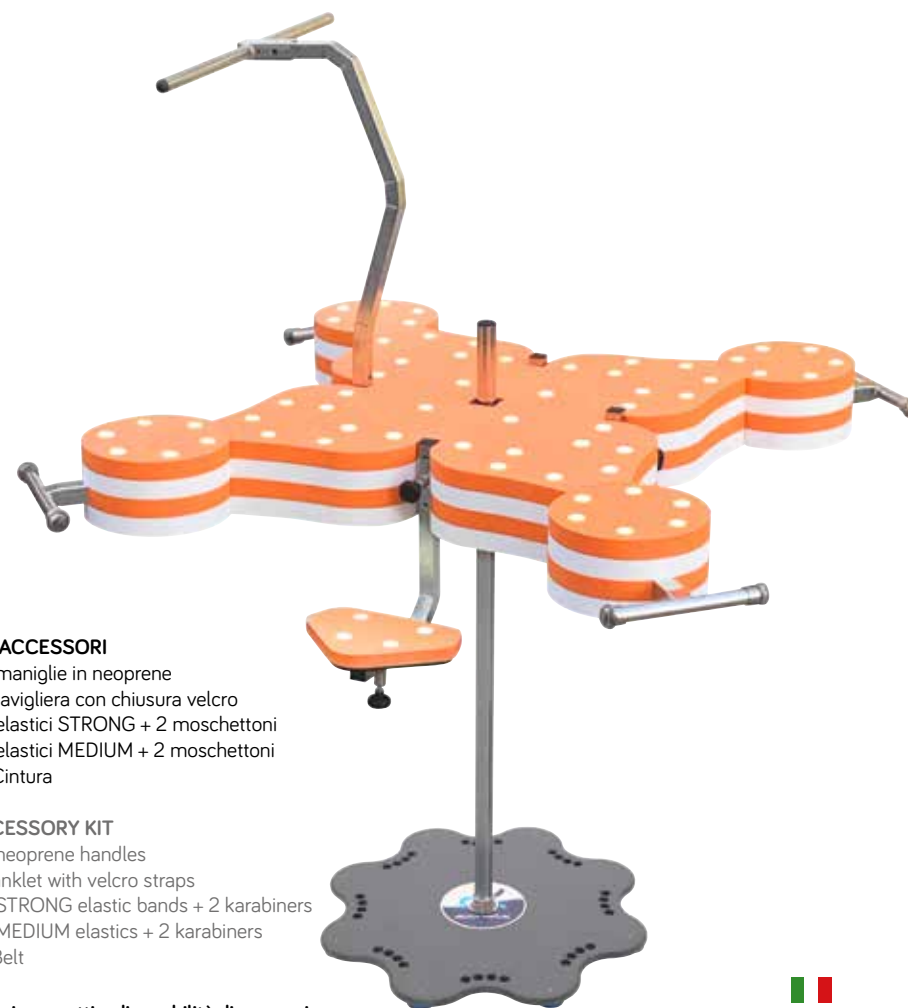

**FLOAT2FITNESS**  
cod. AFA FLO 0001





## VERTICAL DYNAMIC



L'anello permette di regolare il livello del sacco in funzione dell'altezza dell'acqua e della persona, rendendo il suo utilizzo estremamente funzionale

The ring allows to adjust the level of the bag according to the height of water and person, making it extremely functional



Design studiato con appositi fori per agevolare la movimentazione fuori dall'acqua

Studied in detail with special holes to facilitate handling out of the water

- + EXCLUSIVE DESIGN, MADE IN ITALY
- + STABILE IN ACQUA E MANEGGEVOLE FUORI  
STABLE IN WATER AND OUTSIDE
- + SISTEMA INNESTO RAPIDO  
QUICK COUPLING SYSTEM
- + NUOVO KIT ELASTICI  
NEW ELASTICS KIT
- + NUOVA COMBAT BAG  
NEW COMBAT BAG
- + VENTOSE EXTRA TENUTA  
EXTRA STRONG SUCTION CUPS

## VERTICAL DYNAMIC

Optional

Su richiesta | On request



AFA VD 100  
**VD COMBAT BAG**  
1 Combat Bag + 1 anello forato  
1 Combat Bag + 1 ring



AFA VD 101  
**VD TRAINING KIT**  
2 elastici MEDIUM + 4 moschettoni  
2 elastico STRONG + 4 moschettoni  
2 maniglie + 1 cavigliera + 1 cintura + 2 anelli forati  
2 elastic MEDIUM bands + 2 karabiners  
2 elastic STRONG bands + 2 karabiners  
2 handles + 1 ankle cuff + 1 belt + 2 rings

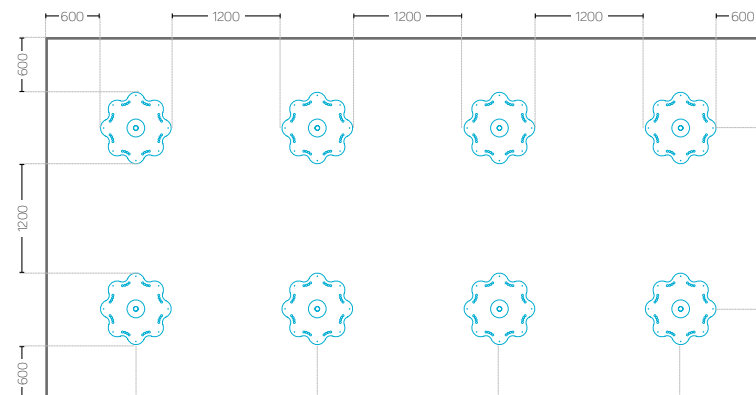

AFA VD 001200 <b>VERTICAL DYNAMIC 200 cm</b>	✓	✓
AFA VD 001250 <b>VERTICAL DYNAMIC 250 cm</b>	✓	✓



**EAA INSTRUCTOR TRAINING:**  
Master **AQUA VERTICAL DYNAMIC**



**Materiale**  
Material

Base: PVC  
Palo: AISI 316L  
Base: PVC  
Pole: AISI 316L

**Profondità d'impiego**  
Depth of use

**200** 100 - 170 cm  
**250** > 170 cm

**Peso**  
Weight

**200** 21 kg  
**250** 24 kg

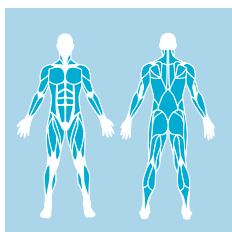
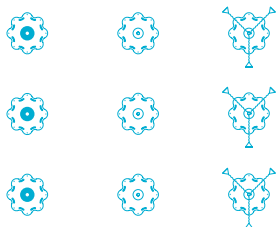

VERTICAL DYNAMIC, nella sua semplicità, rappresenta un punto fermo nelle dotazioni di attrezzi di una vasca.

- Facile movimentazione, gradevolezza del design e ottima stabilità della base in Pvc, dotata di 8 ventose ad alta aderenza.
- Sistema d'innesto dell'asta facile e sicuro, tutto in acciaio inox AISI 316L, garantisce la massima qualità e sicurezza.

La versatilità dell'attrezzo è garantita da:

- un innovativo COMBAT BAG studiato per essere facilmente utilizzabile sia con le braccia che con le gambe, dotato di cerniera per agevolare le operazioni di manutenzione del prodotto;
- possibilità di aggiunta di elastici con maniglie e con cavigliera per garantirne l'utilizzo simultaneo a più persone.

VERTICAL DYNAMIC, with its simplicity, is a must have in every pool's equipment.

- Easy to handle, with a pleasant design and excellent stability of its PVC base, equipped with 8 high-grip suction cups.
- Its simple and safe quick coupling system, made in 316L stainless steel, guarantees maximum quality and safety.

The versatility of the equipment is guaranteed by:

- an innovative COMBAT BAG designed to be easily used with both arms and legs, equipped with a hinge to facilitate the product maintenance operations;
- possibility of adding elastic bands with handles and ankle cuff to guarantee simultaneous use for up to more people.

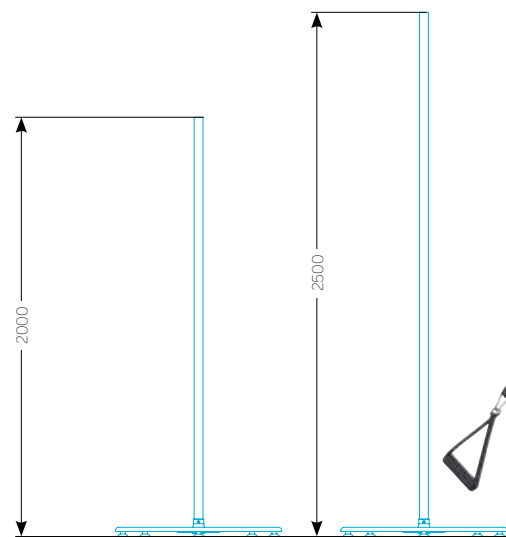

cod. AFA VD 001200  
mod. 200 cm

cod. AFA VD 001250  
mod. 250 cm

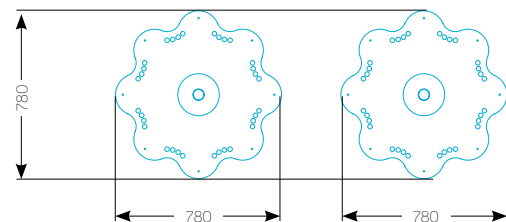

CE



## VERTICAL DYNAMIC

cod. AFA VD 001.200 mod. 200 cm  
cod. AFA VD 001.250 mod. 250 cm



4 comode maniglie  
4 comfortable handles

Anelli per ancoraggio  
Rings for tethering



Superficie antiscivolo  
Non-slip surface



Aqua Fitness Mat è prodotto con materiali d'alta qualità  
Aqua Fitness Mat is produced using high quality materials

## AQUA FITNESS MAT

- + VERSATILITÀ DI UTILIZZO  
VERSATILE USE
- + 4 PUNTI DI ANCORAGGIO  
4 POINTS OF TETHERING
- + AMPIA SUPERFICIE ANTISCIVOLO  
LONG, TEXTURED NON-SLIP DECK
- + PRATICO PORTA OGGETTI ELASTICO  
CONVENIENT BUNGEE POCKET
- + COMODE MANIGLIE IN GOMMA  
COMFORTABLE RUBBER HANDLES
- + FACILE DA TRASPORTARE  
EASILY TO TRANSPORT
- + MATERIALE EXTRARESISTENTE, PVC A DOPPIO STRATO  
EXTRA DURABLE, DOUBLE LAYER OF PVC



Valvola con chiusura di sicurezza  
Valve with safety device

## AQUA FITNESS MAT

Optional  
Su richiesta | On request



AFA 0400  
**Elastici**  
Elastics



AFB 0512  
**Bande Elastiche**  
Elastic bands

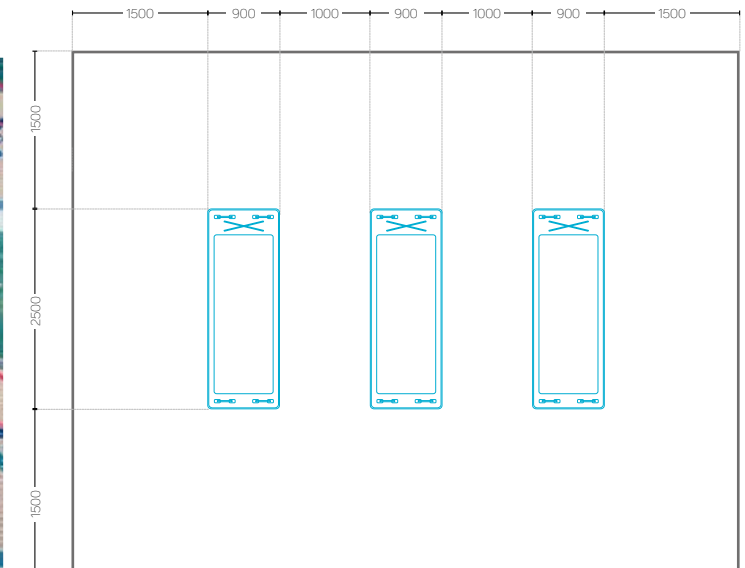

MAT 0001

**AQUA FITNESS MAT**

Tavola  
Mat

Borsa  
Bag





## EAA INSTRUCTOR TRAINING

Master **AQUA FITNESS MAT**



### Materiale Material

PVC + Eva +  
Acciaio AISI 316  
Pvc + Eva + Stain-  
less steel AISI 316

### Profondità d'impiego Depth of use

min. 120 cm

### Dimensioni Dimensions

250 x 90 x 15 cm

### Anelli per ancoraggio Rings for anchoring

8

### Peso (solo materassino) Weight (only the board)

9 kg

### Pressione consigliata Recommended pressure

14 - 18 PSI  
0,97 - 1,24 bar

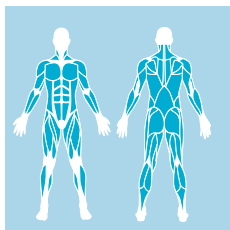

AQUA FITNESS MAT è la soluzione perfetta per proporre lezioni di fitness innovative, divertenti e complete.

- Leggera e gonfiabile, è pensata per ogni contesto acquatico con possibilità di ancoraggio.
- Prodotta con materiali di qualità, AFM è estremamente durevole e garantisce stabilità e sicurezza grazie ai 4 punti di ancoraggio e l'innovativa superficie anti-scivolo.

AQUA FITNESS MAT is the perfect platform to offer innovative, funny and complete fitness classes.

- Light-weight and inflatable, AFM is designed for all aquatic context with the possibility of anchoring.
- AFM is produced with high quality and durable materials to ensure superior safety and stability, featuring 4 points of tethering and the innovative textured, non-slip deck.

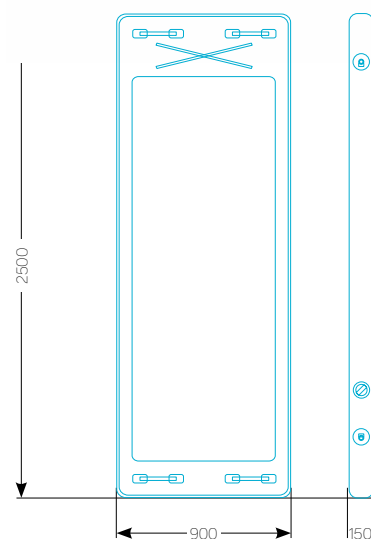

## AQUA FITNESS MAT

cod. MAT 0001

### BORSA BAG



cod. MAT 0002

### KIT ANCORAGGIO + RIPARAZIONE: ANCHORAGE KIT + REPARATION:

4 elastici da 100 cm, 4 elastici da 50 cm + colla e 2 pezze  
4 elastics 100 cm length, 4 elastics 50 cm length + glue and two patches



### cod. MAT 0003 POMPA MANUALE HAND PUMP



Superficie antiscivolo del Pad  
Non-slip surface Pad



Pinna sotto la tavola  
Bottom fin

Pagaia in alluminio, con lunghezza regolabile  
Aluminium paddle with adjustable length



## SUP STAND UP PADDLE

- + 3 DIMENSIONI PER ACQUE LIBERE  
3 SIZES FOR OPEN WATER
- + QUALITÀ DEI MATERIALI  
HIGH-QUALITY MATERIALS
- + VERSATILITÀ DI UTILIZZO  
VERSATILE USE
- + ALLENAMENTO DI TUTTO IL CORPO  
SPECIFIC TRAINING FOR BODY CONTROL
- + SUPERFICIE ANTISCIVOLO  
NON-SLIP SURFACE



Valvola con chiusura di sicurezza  
Valve with safety device

### Optional

Su richiesta | On request



SUP R000 CRB  
Pagaia in carbonio  
Carbon paddle

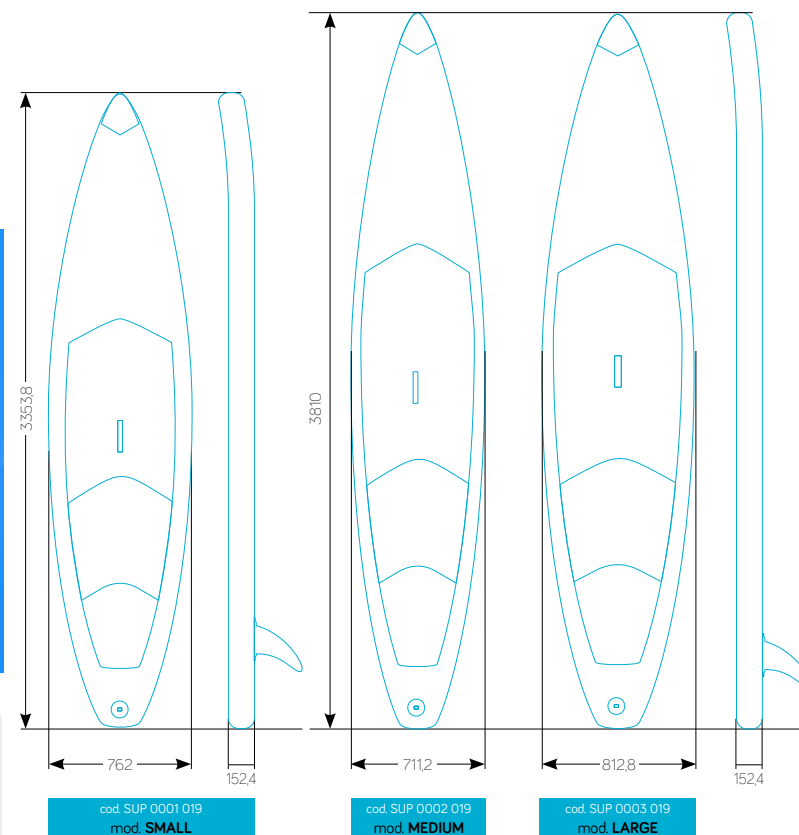

## SUP STANDARD KIT

- SUP 0001 019 **SMALL SUP**
- SUP 0002 019 **MEDIUM SUP**
- SUP 0003 019 **LARGE SUP**

1 Tavola  
1 Board

SUP R000 ALM  
Pagaia in alluminio  
Aluminum paddle

SUP RPMP 001  
Pompa manuale  
Hand pump

SUP RBRS 001  
Borsa  
Bag

SUP RKRP 001  
Kit riparazione  
Repair kit

cod. SUP 0001 019  
mod. **SMALL**

cod. SUP 0002 019  
mod. **MEDIUM**

cod. SUP 0003 019  
mod. **LARGE**



<b>Materiale</b> Material	PVC + Eva + Acciaio AISI 316
<b>Profondità d'impiego</b> Depth of use	acque libere
<b>Lunghezza pagaia</b> Paddle length	regolabile adjustable
<b>Peso</b> Weight	<b>SMALL</b> 11,2 kg <b>MEDIUM</b> 12 kg <b>LARGE</b> 13,8 kg
<b>Pressione consigliata</b> Recommended pressure	14 - 18 PSI 0,97 - 1,24 bar

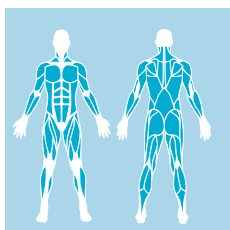

Tavole gonfiabili, indicate per praticare il SUP in acque libere, ovvero *Stand up Paddle*: attività semplice e divertente, accessibile a tutti, senza limiti di età e forma fisica.

Il gioco stabilità/instabilità, unito all'utilizzo della pagaia, garantisce un valido mezzo di allenamento per tutto il corpo.

Le tavole sono disponibili in 3 dimensioni, ordinabili in base alla tipologia di utente: **principiante, praticante, esperto**

**SUP 0001 019 SMALL BOARD**  
11' x 30" x 6" (335,28 x 76,20 x 15,24 cm)

Tavola per **principianti** (bambini e adulti): soluzione più pratica, indicata per percorsi brevi.

**SUP 0002 019 MEDIUM BOARD**  
12'6" x 28" x 6" (381,00 x 71,12 x 15,24 cm)

Tavola per **esperti** (ragazzi e adulti): soluzione più performante, indicata per lunghi tragitti.

**SUP 0003 019 LARGE BOARD**  
12'6" x 32" x 6" (381,00 x 81,28 x 15,24 cm)

Tavola per **praticanti** (ragazzi e adulti): soluzione performante, indicata per lunghi tragitti, ma adatta a chi cerca più stabilità o per persone "oversize".

Inflatable boards, suitable for practising SUP (Stand Up Paddle) in open water: a simple and fun activity, accessible to everyone, regardless of age or physical limits.

SUP is a complete workout that improves athletic ability and balance by effectively working all muscle areas.

The boards are available in 3 sizes, which can be categorised based on the type of user: **beginner, experienced, expert**

**SUP 0001 019 SMALL BOARD**  
11' x 30" x 6" (335.28 x 76.20 x 15.24 cm)

Board for **beginners** (children and adults): a more practical solution, suitable for shorter routes.

**SUP 0002 019 MEDIUM BOARD**  
12'6" x 28" x 6" (381.00 x 71.12 x 15.24 cm)

Board for **expert** users (kids and adults): a more performing solution, suitable for longer itineraries.

**SUP 0003 019 LARGE BOARD**  
12'6" x 32" x 6" (381.00 x 81.28 x 15.24 cm)

Table for **experienced** users (children and adults): a performing solution, suitable for longer journeys, but also suitable for those seeking more stability and for larger users.



## SUP

### STAND UP PADDLE

cod. SUP 0001 019 **SMALL**  
cod. SUP 0002 019 **MEDIUM**  
cod. SUP 0003 019 **LARGE**



## PUZZLE STEP

- + STEP MADE IN ITALY
- + EXCLUSIVE ITALIAN DESIGN
- + PRODOTTO BREVETTATO  
PATENTED PRODUCT
- + 6 VENTOSE PER ADERENZA AL FONDO  
6 STRONG SUCTION CUPS
- + INGOMBRI RIDOTTI  
REDUCED DIMENSIONS
- + 10 FORI PER ASSEMBLAGGIO PIÙ PEZZI  
10 HOLES TO ASSEMBLY MORE PIECES
- + FORNITO CON 2 PESETTI  
SUPPLIED WITH 2 WEIGHTS

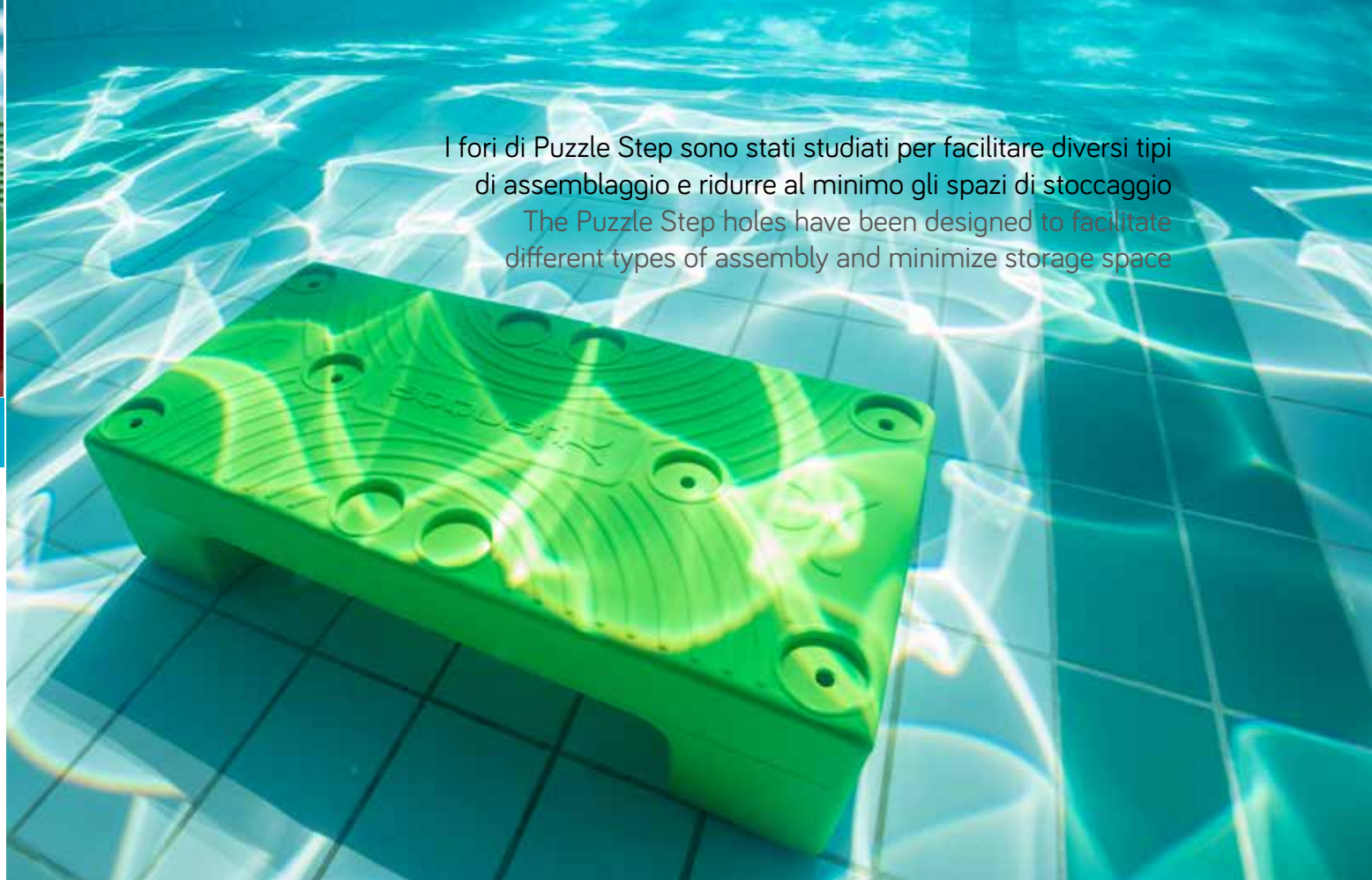

I fori di Puzzle Step sono stati studiati per facilitare diversi tipi di assemblaggio e ridurre al minimo gli spazi di stoccaggio  
The Puzzle Step holes have been designed to facilitate different types of assembly and minimize storage space



Puzzle Step in fase di stoccaggio  
Puzzle Step storage



Si possono creare piattaforme per attività ludo-didattiche coi bambini...  
You can create platforms for play and pedagogical activities with children...

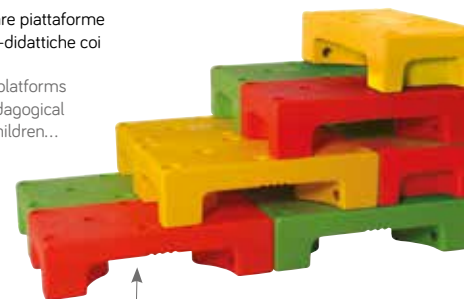

...oppure comode scalette per facilitare l'accesso o l'uscita dall'acqua  
...or comfortable ladders to facilitate entering and leaving the water

Orange

Yellow

min. | moq. 10 pz  
consegna | delivery 60 gg.

Lime  
NEW COLOUR

Green



### EAA INSTRUCTOR TRAININGS:

Master **AQUA STEP & JUMP**

Master **AQUA CIRCUIT**

Master **AQUAxFIT®**

Course **AQUA PERSONAL PROGRAM**



**Materiale**  
Material

Polietilene  
Polyethylene

**Profondità d'impiego**  
Depth of use

120 - 140 cm

**Peso**  
Weight

6 kg

**Dimensioni**  
Dimensions

70 x 35 x h 19 cm

### QUALI VENTOSE SCEGLIERE? WHICH KIND OF SUCTION CUP?



**AFA RGEN 003**  
consigliata per vasche con **SUPERFICI LISCE** (pvc liscio, ceramica liscia...)  
suggested for **SMOOTH SURFACE** pools  
(smooth pvc, smooth ceramic...)



**AFA RGEN A03**  
consigliata per vasche con **SUPERFICI SEMI RUVIDE O IRREGOLARI**  
(mosaico, inox bugnato, ceramica ruvida, pvc ruvido...)  
suggested for **UNEVEN OR IRREGULAR SURFACE** pools  
(mosaic, embossed stainless steel, rough ceramic ruvida, rough pvc...)

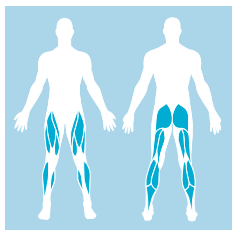

Il PUZZLE è uno STEP modulare, unico al mondo.

- Progettato dal centro R&D di Aquatix.
- La sua originalità, oltre a forma e dimensioni, sta nella realizzazione di fori sulla superficie di appoggio che garantiscono stabilità anche in caso di più attrezzi sovrapposti.

PUZZLE STEP, is a modular step, one of a kind.

- Designed and developed by the Aquatix R&D Centre.
- Its original design, in addition to the shape and dimensions, is evident from the holes on the surface, which ensure stability even in case of overlapped Steps.



cod. AFT 0018 B  
**PUZZLE STEP CON VENTOSE BLU**

Ventose utili per vasche con fondo a mosaico.

Attenzione: in questo modo gli step non sono impilabili.

Blue suction cups recommended for mosaic floor.

Please note: the steps in this case are not stackable.

## PUZZLE STEP

cod. AFT 0018

mod. **STANDARD**

cod. AFT 0018 B

mod. **VENTOSE BLU**

mod. **BLUE SUCTION CUPS**





3 Moon Bite Step formano 1 Acqua Circle Step  
Three Moon Bite Steps constitute an Acqua Circle Step

## MOON BITE STEP

- + STEP MADE IN ITALY
- + EXCLUSIVE ITALIAN DESIGN
- + 8 VENTOSE PER ADERENZA AL FONDO  
8 STRONG SUCTION CUPS
- + ESCLUSIVA FORMA SEMICIRCOLARE  
ESCLUSIVE DESIGNED TO FORM A 1/3 CIRCLE
- + DUE PERSONE PER STEP  
TWO PERSONS PER STEP.
- + 3 STEP FORMANO UN CERCHIO  
3 STEPS CONSTITUTE A CIRCLE



L'esclusiva forma di Moon Bite Step è unica al mondo e permette di creare un grande step circolare, ma anche diversi percorsi alternativi

The exclusive shape of Moon Bite Step is unique in the world and allows you to create a large circular step but also different alternative routes





### EAA INSTRUCTOR TRAININGS:

Master **AQUA STEP & JUMP**

Master **AQUA CIRCUIT**

Master **AQUAxFIT®**

Course **AQUA PERSONAL PROGRAM**



**Materiale**  
Material

Polietilene  
Polyethylene

**Profondità d'impiego**  
Depth of use

120 cm

**Peso**  
Weight

AFT 0014 10 kg  
AFT 0015 30 kg

**Dimensioni**  
Dimensions

AFT 0014 120 x h 20 cm  
AFT 0015 160 x h 20 cm

### QUALI VENTOSE SCEGLIERE? WHICH KIND OF SUCTION CUP?



**AFA RGEN 003**  
consigliata per vasche con **SUPERFICI LISCE** (pvc liscio, ceramica liscia...) suggested for **SMOOTH SURFACE** pools (smooth pvc, smooth ceramic...)



**AFA RGEN A03**  
consigliata per vasche con **SUPERFICI SEMI RUVIDE O IRREGOLARI** (mosaico, inox bugnato, ceramica ruvida, pvc ruvido...) suggested for **UNEVEN OR IRREGULAR SURFACE** pools (mosaic, embossed stainless steel, rough ceramic ruvida, rough pvc...)

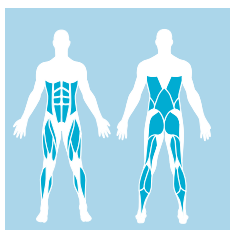

### Modello solo su richiesta: minimo quantitativo 50 pezzi.

Step modulare, unico al mondo: progettato dal centro R&D di Aqqatix. La sua originalità sta nella forma e nelle dimensioni:

- è realizzato per essere pari ad 1/3 di cerchio ("un morso di luna")
- consente l'utilizzo a due persone contemporaneamente.
- la forma semicircolare permette di creare percorsi alternativi.

### Model exclusively on request: minimum quantity of 50 pieces.

Modular step, one of a kind, patented: designed and developed by the Aqqatix R&D Centre.

Its original design is evident from the shape and dimensions.

- It's designed to form a 1/3 circle (the "moon bite")
- It can be used by two persons simultaneously.
- The semicircular shape allow to create different circuit.



### AQUA CIRCLE STEP

cod. AFT 0015



### Modello solo su richiesta: minimo quantitativo 50 pezzi.

Tre Moon Bite Step uniti formano un grande step circolare, che consente di coinvolgere fino a 6-8 persone contemporaneamente.

Rivoluzionaria attività in acqua:

- aqua circuit
- didattica
- divertimento.

### Model exclusively on request: minimum quantity of 50 pieces.

Three Moon Bite Step joined together constitute a large circular step that can involve up to 6-8 people at the same time.

Not only for aqua fitness:

- aqua circuit
- learning
- fun.





**aqquatix**<sup>®</sup>  
equipment for very aqquatix people

**AQQUATIX SRL**  
Limena (Padova)  
ITALY  
T. +39 049 738 11 50

**[www.aqquatix.com](http://www.aqquatix.com)**  
Italy: [info@aqquatix.com](mailto:info@aqquatix.com)  
Export: [export@aqquatix.com](mailto:export@aqquatix.com)

Training by EAA  
[www.euroaquatic.it](http://www.euroaquatic.it)